

SYRINGE SELECTION

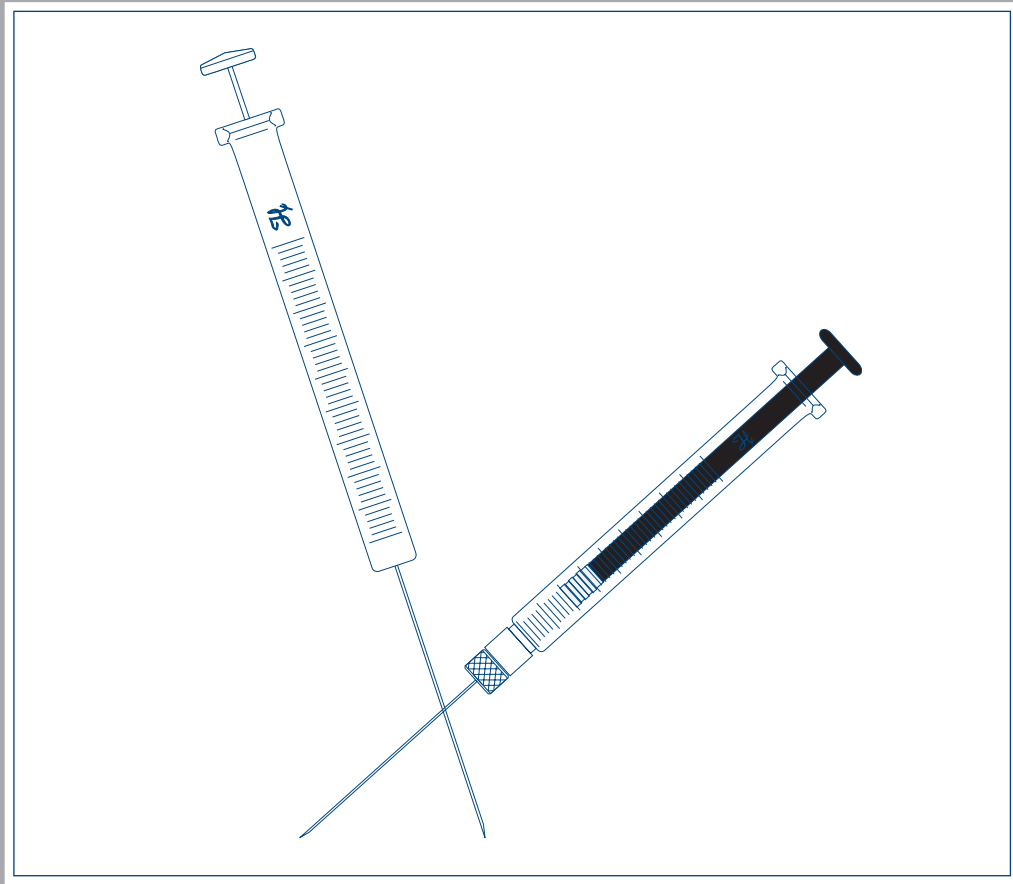

**Complete Guide to Selecting the Right
Hamilton GASTIGHT®, MICROLITER™, and
Specialty Syringe for Your Application**



HAMILTON 
THE MEASURE OF EXCELLENCE™

Table of Contents

Introduction	3
Syringe Schematics	4
Selecting the Right Syringe for Your Application – Step-by-Step Guide	4
Hamilton Syringe Selection Worksheet	5
Example of Completed Hamilton Syringe Selection Worksheet	6
1. Syringe Types	7
2. Syringe Series	8
Syringe Types to Series Chart	8
3. Series Descriptions	9
MICROLITER Syringes (0.05 µL - 500 µL)	9
600 Series (0.25 µL - 5 µL)	9
700 Series (0.5 µL - 500 µL)	9
800 Series (0.5 µL - 250 µL)	10
900 Series (0.5 µL - 10 µL)	10
7000 Series (0.05 µL - 5 µL)	10
GASTIGHT Syringes (1 µL - 2L)	11
1000 Series (100 µL - 100 mL)	11
1700 Series (1 µL - 500 µL)	11
1800 Series (1 µL - 250 µL)	12
Super Syringe (50 mL - 2L)	12
4. Terminations	13
N, Cemented Needle	13
SN, Special Cemented Needle	13
LTN, Luer Tip Cemented Needle	13
LTSN, Luer Tip Special Cemented Needle	13
LT, Luer Tip	13
RN, Removal Needle	14
KH, Knurled Hub	14
TLL, PTFE Luer Lock	14
SL, SampleLock™	14
5. Needle Selection	15
Standard Needles	15
Custom Needles	15
Custom Needle Hubs	15
Point Styles and Applications	16
Needle Point Style Chart	16
Gauge and Length	17
Gauge Index Table	17
Accessories, Replacement Parts, and Services	18
Additional Technical Information	19
Technical Support	19

Introduction

Hamilton syringes are the finest quality precision fluid measuring devices available. We offer the most complete selection of syringes on the market for use in applications that range from simple liquid transfers to animal injections to complex GC and HPLC chromatographic injections.

In this guide, all the information needed to select the right syringe for manual applications is presented. In addition, Hamilton offers a complete line of syringes for use with instrumentation such as autosamplers and syringe pumps, including replacement syringes for pumps produced by other manufacturers. Top quality materials and skilled workmanship ensure that Hamilton syringes consistently deliver the highest possible performance for reliable analyses.

Our syringes are accurate to within $\pm 1\%$ of nominal volume with a precision of 1% at 80% of the total volume. The fluid path of a Hamilton syringe is designed to be chemically inert with stainless steel, borosilicate type I glass, and PTFE used for most syringes. N.I.S.T. traceable certification is available, as an additional service, for the majority of the syringes in our product line.

All Hamilton products are unconditionally guaranteed to be free of defects in materials and workmanship for one year (12 months) from date of purchase. The Hamilton Company Quality System is ISO 9001-2000 Certified. Syringes and needles manufactured by Hamilton Company are intended for scientific research and laboratory use only and are not intended for human in vivo use. Consult our published specifications to determine the material compatibility of Hamilton products with your application.

Hamilton continuously researches new materials and methods to improve form, fit, and function of our syringes, so you can be confident that when you buy from Hamilton you are on the cutting edge. For the latest information on new products, detailed product and part descriptions, published specifications, and our *Guide to Maintaining and Using Hamilton Syringes*, please visit www.hamiltoncompany.com



Syringe Schematics

Examples of Hamilton MICROLITER and GASTIGHT Precision Syringes

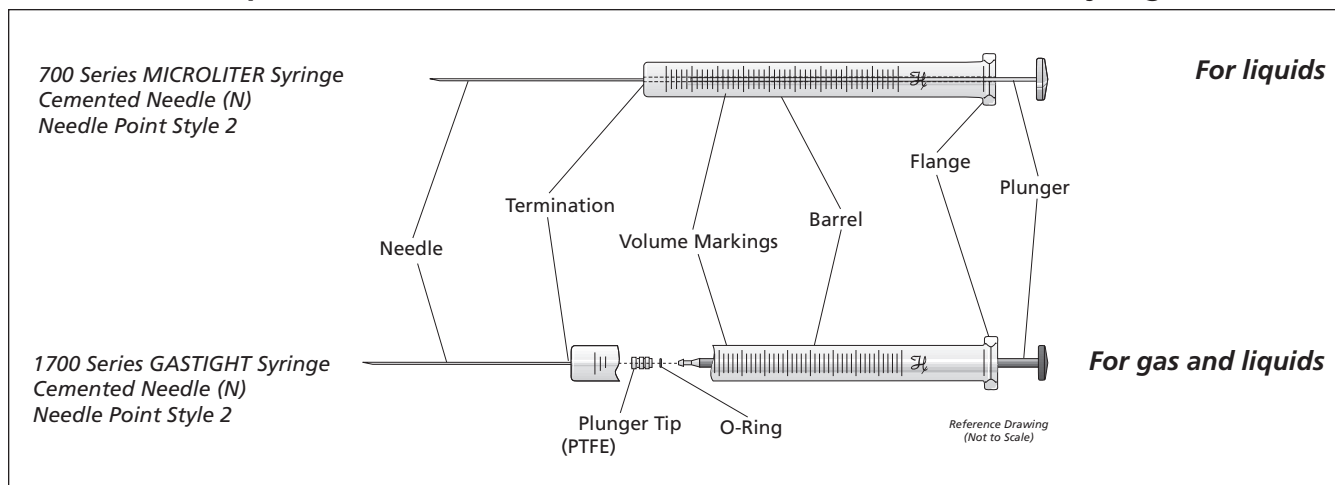

MICROLITER syringes have a stainless steel plunger which is individually hand-fitted to its matching glass barrel. The hand-fitting process is finely controlled to create a liquid-tight seal between the barrel and the plunger. Plungers for MICROLITER syringes cannot be interchanged or replaced if damaged.

GASTIGHT syringes have a precision machined PTFE plunger tip which provides a tight seal for both liquids and gases. Replacement plunger assemblies are available for most GASTIGHT syringes.

Selecting the Right Syringe for Your Application Step-by-Step Guide

Hamilton offers seven core series with a wide range of delivery volumes, termination types, needle gauges, and needle point styles plus numerous speciality syringes. Hamilton's syringe series are grouped by sample type, application, and volume range. Our syringes are further supported by an array of accessories to improve durability and reproducibility.

Use our five-step guide and worksheet to choose the ideal syringe for your application. The next page is a blank Hamilton Syringe Selection Worksheet. The blank

worksheet is followed by a sample of a completed worksheet. Instructions for using the worksheet are included on the form. Once the worksheet is completed, you can fully describe the syringe needed for your application.

Note: you may want to make copies of the blank worksheet for future use or you can download a copy by visiting www.hamiltoncompany.com

Hamilton Syringe Selection Worksheet

To use this worksheet, first define the sample type and required dispensing volume. Next, read each step, and for additional details go to the appropriate reference section in this guide. Choose the feature needed and, enter your selection on the worksheet. On completion, this

worksheet will fully describe the Hamilton syringe needed for your application. Visit www.hamiltoncompany.com to identify the part number or call 1-888-525-2123 for Hamilton Customer Service assistance. Call your local dealer for assistance outside the U.S.

Steps to Choosing a Syringe

1. See *Syringe Types, pg. 7*, to decide whether a GASTIGHT or a MICROLITER syringe is best for the application.

Note: GASTIGHT syringes are recommended for viscous samples. With MICROLITER syringes, it is possible for air to slip past a plunger as a vacuum is created.

2. Use the *Syringe to Series Chart, pg. 8*, to determine the available syringe series in the volume range needed.
3. See the *Series Descriptions, pg. 9*, to determine the most appropriate series, and the available volumes and terminations for that series.
4. See *Terminations, pg. 13*, to determine the most suitable termination.
5. See *Needle Selection, pg. 15*, to determine the most appropriate needle if a termination or application requires the selection of a specific needle.
 - a. Standard Needles. Most Hamilton syringes are available with 2 in. needles of an appropriate gauge with either Point Style 2 (sharp point) or Point Style 3 (blunt point).
 - b. Custom Needles. If the application requires a non-standard length, gauge or point style, then Hamilton offers several custom options. See *Custom Needles, pg. 15*, to determine the appropriate needle for any application.

Your Selection

1. GASTIGHT _____
MICROLITER _____
Your dispensing volume in μL _____
2. Series available _____

3. Series selected _____
Volume selected _____
Terminations available _____

4. Terminations selected _____
5. Standard Needle
Point Style 2 _____
Point Style 3 _____
Custom Needle
Gauge _____
Length in inches _____
Point Style _____
Needle Hub _____

The Right Hamilton Syringe for My Application is:

_____ Type _____ Series _____ Volume _____ Termination _____ Needle _____

Example of Completed Worksheet

In this example, Jane needs a syringe that is capable of doing nine rapid 10 µL injections of a blood serum solution for a nitric oxide study using GC analysis.

Steps to Choosing a Syringe

1. See *Syringe Types, pg. 7*, to decide whether a GASTIGHT or a MICROLITER syringe is best for the application.

Jane's sample is a liquid, but it is viscous and contains numerous dissolved components that over time could cause a fitted plunger to freeze, so she elects to use a GASTIGHT syringe.

2. Use the *Syringe to Series Chart, pg. 8*, to determine the available syringe series in the volume range needed.

Using the chart, she determines that syringes in the 1700 and 1800 series are available in her volume range.

3. See the *Series Descriptions, pg. 9*, to determine the most appropriate series, and the available volumes and terminations for that series.

From the descriptions, she determines that although the 1700 series would work, the 1800 series has a supported plunger which eliminates the chance of bending the fragile plunger during the nine rapid injections. She selects the appropriate volume and lists the terminations available for the 1800 series syringes.

4. See *Terminations, pg. 13*, to determine the most suitable termination.

She sees that the 1800 series syringes are available with either Cemented Needle or Removable Needle terminations. She determines that a Removable Needle is the most appropriate termination because if her serum sample clogs the needle she can replace the needle and not the whole syringe.

5. See *Needle Selection, pg. 15*, to determine the most appropriate needle if a termination or application requires the selection of a specific needle.

Since a standard needle is suitable for her application, Jane does not need to supply information for a custom needle.

Your Selection

1. GASTIGHT **X**

MICROLITER

Your dispensing volume in µL **10 µL**

2. Series available **1700 and 1800**

3. Series selected **1800**

Volume selected **10 µL**

Terminations available **N and RN**

4. Terminations selected **RN**

5. Standard Needle
Point Style 2 **X**

Point Style 3

The Right Hamilton Syringe for My Application is:

 GASTIGHT
Type

 1800
Series

 10 µL
Volume

 RN
Termination

 Std. Point Style 2
Needle

Jane calls Hamilton Customer Service and orders a GASTIGHT 1800 series 10 µL syringe with a RN hub and a standard sharp needle (Point Style 2).

1. Syringe Types

Key to selecting the right syringe for your application is to identify your sample type and determine the smallest volume to be dispensed or injected. Hamilton offers two types of syringes, GASTIGHT and MICROLITER, which differ in the design of the plunger.

GASTIGHT Syringes for Gases and Liquids

GASTIGHT syringes have a precision-machined PTFE plunger tip which creates a leak-free seal. With the tight fit, the tip essentially wipes the interior of the syringe barrel free of sample. This feature is particularly useful with heterogeneous samples as it reduces the chance that a deposit will occur and cause the plunger to freeze.

The GASTIGHT series still requires careful and regular cleaning to minimize deposits on the glass which might score the soft PTFE plunger tip and resulting in a leak. Replacement plunger assemblies are available for GASTIGHT syringes. However, a replacement plunger should not be put into a barrel which still contains deposits because the new plunger tip is likely to be scored by the deposit after only a few strokes. It is important to remember that over time, the increased friction created by the tight seal may cause the PTFE tip to wear out and the plunger will have to be replaced.

MICROLITER Syringes for Liquids

MICROLITER syringes incorporate a hand-fitted stainless steel plunger with a finely bored syringe barrel. These syringes are ideal for homogenous samples that are not prone to precipitation or bonding with glass.

Under the proper conditions, plunger wear is minimal and the life of a MICROLITER syringe is almost unlimited. However, when using heterogeneous solutions with a MICROLITER syringe, the user must be especially diligent about cleaning the syringe after each use. For more information, see our *Guide to Maintaining and Using Hamilton Syringes*.

In some cases, even diligent cleaning is not sufficient and the barrel will become soiled. The deposits on the glass will compromise the tight tolerances between the glass and the plunger resulting in a frozen plunger. Plungers for MICROLITER syringes cannot be interchanged or replaced if damaged. For heterogeneous solutions, a GASTIGHT syringe is the best option.

2. Syringe Series

For gas samples and heterogeneous liquids, there are four GASTIGHT syringe series from which to choose. For homogeneous liquid samples, there are five MICROLITER syringe series. Given the variety of syringe series available with MICROLITER and GASTIGHT plungers, an easy way to narrow down the list of series is to use delivery (or dispensing) volume as a discriminating factor. For the most accurate dispenses always choose a syringe that has a nominal volume as close to the dispense volume as possible.

For accuracy and precision, the smallest dispensing volume for a given syringe should be greater than or equal to 10% of its total capacity. For example, the smallest dispensing volume recommended for a 10 μL syringe is 1 μL . The following Syringe Type to Series Chart shows the volumes that each series is capable of dispensing within 10-100% of the syringes' nominal volume.

The Hamilton Syringe Type to Series Chart

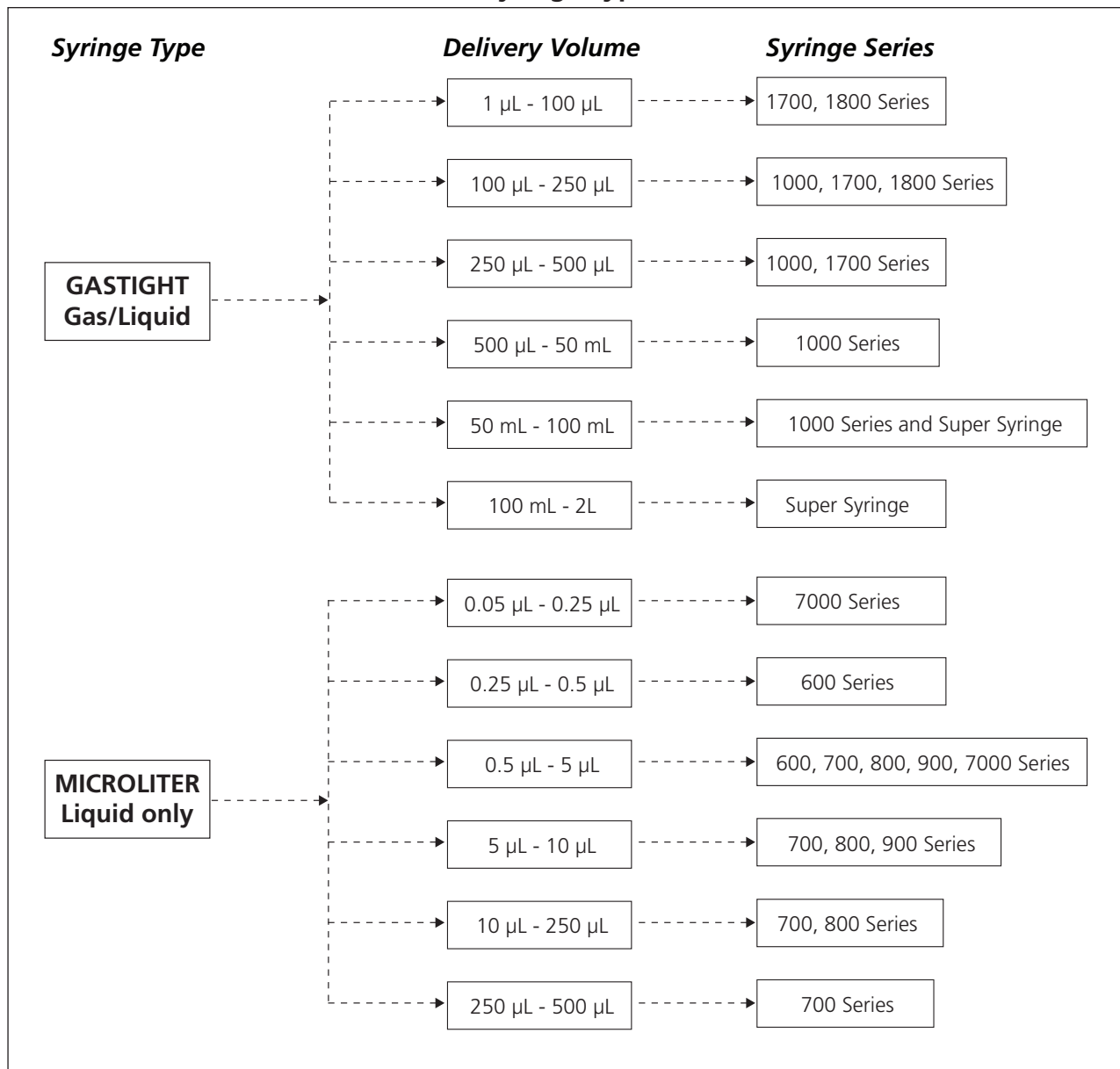

3. Series Descriptions

Complete descriptions for Hamilton syringe series used for manual applications are given below. The descriptions include product features and typical applications along with the volumes, terminations, and accessories available for each series. For some volumes, several series may include syringes with equivalent volume ranges and similar terminations.

MICROLITER Syringes (0.05 μL - 500 μL Delivery Volume)

This type of syringe is for use with liquids and incorporates a stainless steel plunger that is individually fitted to its matching syringe barrel. These micro-volume syringes have a very close tolerance between the plunger and the barrel which creates a liquid-tight seal without parts such as O-rings that eventually wear out.

600 Series (0.25 μL - 5 μL Delivery Volume)

The 600 series are robust syringes consisting of two distinct parts. The bottom half of the barrel accurately measures the liquid sample and the top half supports the plunger. In addition, the top section of the plunger is thicker to further reduce the risk of bending the plunger. These syringes require half of the standard stroke length making them ideal for one-handed operation. The plungers and barrels are not interchangeable or replaceable.

Recommended Use: The 600 series is great for animal injections because one hand is free for manipulating the animal.

Volumes: 2.5 μL and 5 μL

Terminations: Removable Needle (RN)

Accessories: Syringe Guide and Reproducibility Adapter

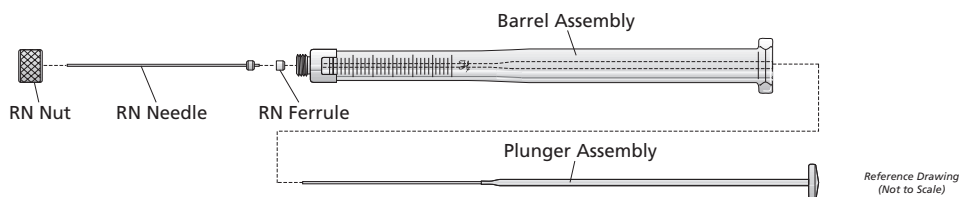

700 Series (0.5 μL - 500 μL Delivery Volume)

The 700 series is the original Hamilton syringe. It was designed to solve the general liquid handling requirements of manufacturing and research laboratories and remains the industry standard. The plungers and barrels are not interchangeable or replaceable.

Recommended Use: The 700 series is used for manual and automated GC and HPLC injections. Also, it is used for everyday applications that require accurate measuring and dispensing of liquid.

Volumes: 5 μL , 10 μL , 25 μL , 50 μL , 100 μL , 250 μL , and 500 μL

Terminations: Cemented Needle (N), Special Cemented Needle (SN), Removable Needle (RN) and Luer Tip (LT)

Accessories: PB600 Repeating Dispenser, Reproducibility Adapter, Syringe Guide, and Digital Syringe

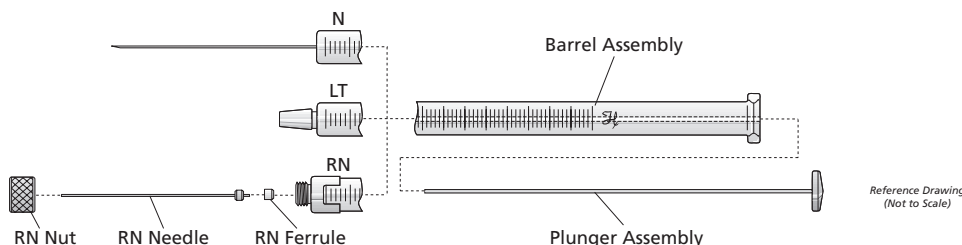

800 Series (0.5 µL - 250 µL Delivery Volume)

The 800 series has the same liquid handling capabilities as the 700 series, but with the addition of an aluminum syringe holder designed to eliminate the possibility of plunger damage. The syringe holder screws onto the glass barrel. A two-piece extended plunger further eliminates the risk of breakage. A friction screw at the top of the barrel can be adjusted to give the user some control over dispensing speed and prevent the accidental removal of the plunger. In addition, the syringe holder can be fitted with different barrel/plunger assemblies to cover a range of volumes.

Recommended Use: This syringe is intended for applications where the plunger on a 700 series syringe might be bent. Excellent for novice users.

Volumes: 5 µL, 10 µL, 25 µL, 50 µL, 100 µL, and 250 µL

Terminations: Cemented Needle (N), Special Cemented Needle (SN), and Removable Needle (RN)

Accessories: Reproducibility Adapter

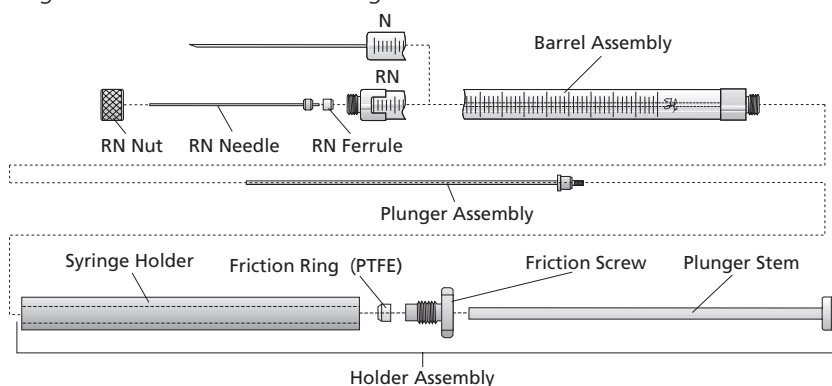

900 Series (0.5 µL - 10 µL Delivery Volume)

The 900 series has the same liquid handling capabilities as the 800 series but is a more economical version. The 900 series does not have any replaceable parts making the initial cost less than the 800 series.

Recommended Use: This syringe is perfect when a robust syringe is desired and budget is a consideration.

Volumes: 5 µL and 10 µL

Terminations: Cemented Needle (N), Special Cemented Needle (SN), and Removable Needle (RN)

Accessories: Reproducibility Adapter

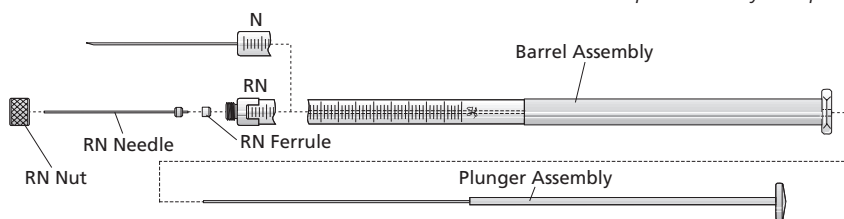

7000 Series (0.05 µL - 5 µL Delivery Volume)

The 7000 series employs a plunger wire inside the needle to accurately dispense ultra-low volumes. The needle is bored to extremely accurate tolerances to accommodate the plunger wire. With the plunger inside the needle, the standard dead volume inside the needle is eliminated.

Recommended Use: The 7000 series is used for manual and automated GC and HPLC injections. Also, it is used for everyday applications that require ultra-small measurements of liquid.

Volumes: 0.5 µL, 1 µL, 2 µL, and 5 µL

Terminations: Knurled Hub (KH)

Accessories: Reproducibility Adapter, Syringe Guide, Digital Syringe, and Syringe Cleaner

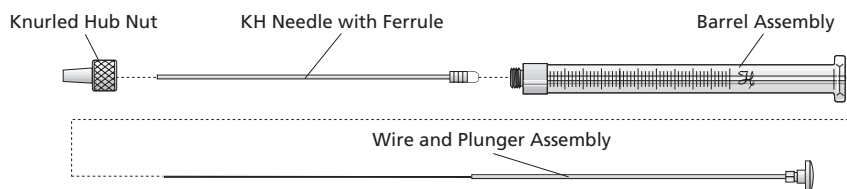

GASTIGHT Syringes (1 μ L - 100 mL Delivery Volume)

These syringes can be used with both gases and liquids. The precision-machined PTFE plunger tip creates a leak-free seal. The plungers are replaceable.

1000 Series (100 μ L - 100 mL Delivery Volume)

The 1000 series is a mid-volume solution for all liquid and gas handling needs.

Recommended Use: The 1000 series is ideal for manual and automated HPLC injections. This syringe is commonly used in syringe pumps and other liquid handling instrumentation.

Volumes: 1 mL, 1.25 mL, 2.5 mL, 5 mL, 10 mL, 25 mL, 50 mL, and 100 mL

Terminations: Luer Tip Cemented Needle (LTN), Luer Tip Special Cemented Needle (LTSN), Luer Tip (LT), Removable Needle (RN), SampleLock (SL), and PTFE Luer Lock (TLL)

Accessories: PB600 Repeating Dispenser for volumes (1 to 2.5 mL)

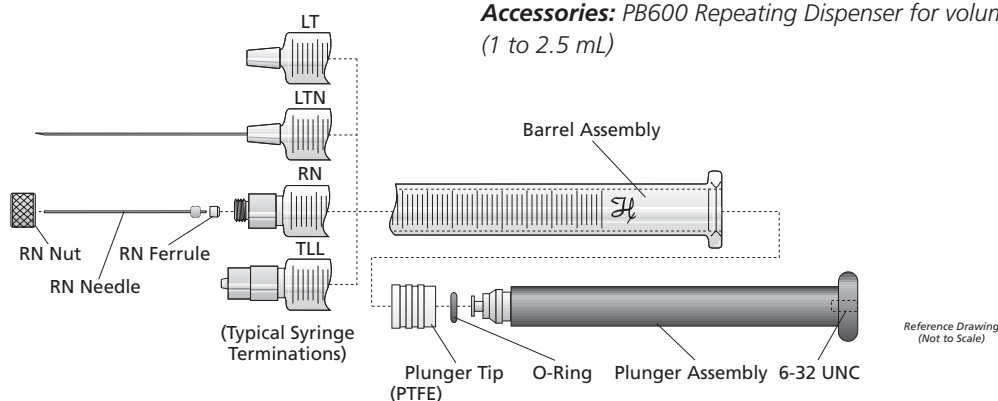

1700 Series (1 μ L - 500 μ L Delivery Volume)

This is the GASTIGHT version of the original Hamilton 700 series syringe. It was designed to meet the low volume gas or liquid handling needs of research and manufacturing laboratories.

Recommended Use: The 1700 series is excellent for manual and automated GC and HPLC injections. This syringe is commonly used in syringe pumps and other liquid handling instrumentation.

Volumes: 10 μ L, 25 μ L, 50 μ L, 100 μ L, 250 μ L, and 500 μ L

Terminations: Cemented Needle (N), Special Cemented Needle (SN), Luer Tip Cemented Needle (LTN), Luer Tip Special Cemented Needle (LTSN), Luer Tip (LT), Removable Needle (RN), SampleLock (SL), and PTFE Luer Lock (TLL)

Accessories: PB600 Repeating Dispenser, Reproducibility Adapter, Syringe Guide, and Digital Syringe

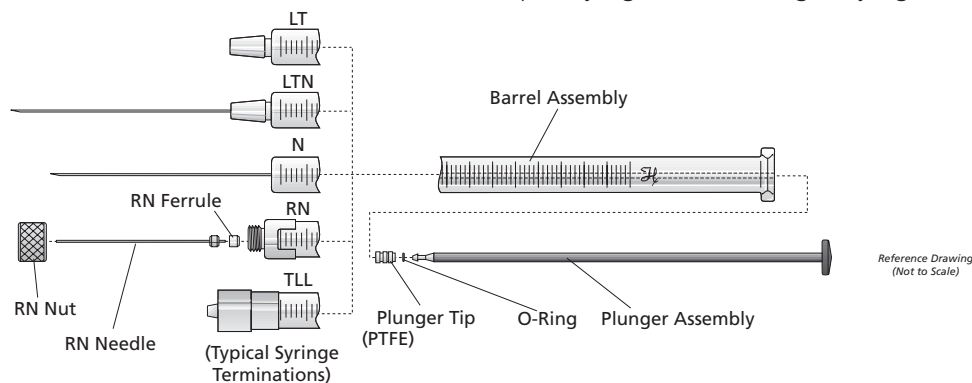

1800 Series (1 μ L - 250 μ L Delivery Volume)

The 1800 series was designed to eliminate the possibility of plunger damage. It has the same liquid handling capabilities as the 1700 series but the extended plunger eliminates breakage and allows the user some control over the dispense speed.

Recommended Use: This syringe is intended for applications where the plunger on a 1700 series syringe might be bent.

Volumes: 10 μ L, 25 μ L, 50 μ L, 100 μ L, and 250 μ L

Terminations: Cemented Needle (N) and Removable Needle (RN)

Accessories: Reproducibility Adapter

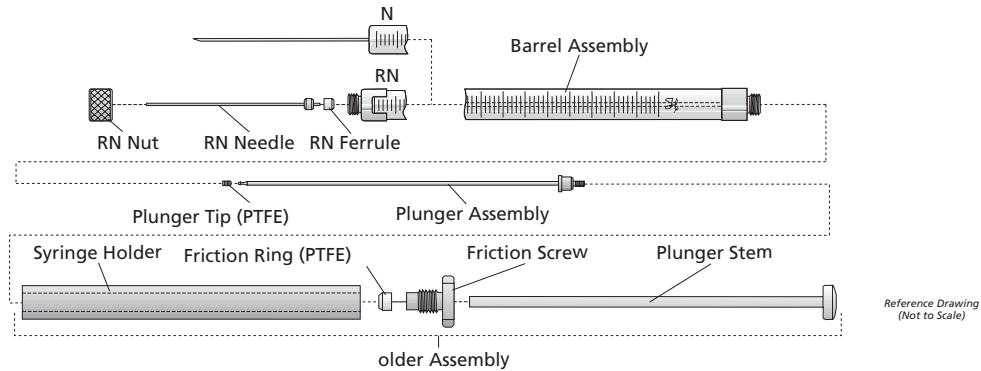

Super Syringes - Specialty Syringes for Gases

Super Syringe (50 mL - 2L Delivery Volume)

Super Syringes were designed primarily for air sampling, preparing gas standards, calibrating reservoirs, and pneumographs. The Super Syringe is the only Hamilton syringe with an acrylic barrel, which makes this syringe slightly less chemically resistant.

Recommended Use: This syringe is intended for sampling or transfer of gases.

Volumes: 0.5L, 1L, 1.5L, and 2L

Terminations: PTFE Luer Lock (TLL) and Tracheal Adapter (accepts 5/8 inch I.D. flexible tubing)

Accessories: None

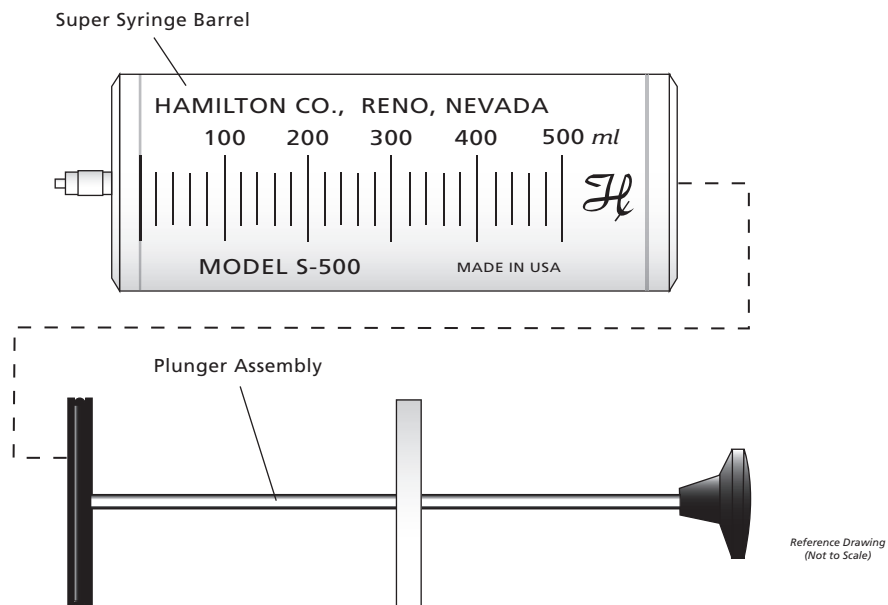

4. Terminations

Terminations are located at the end of the syringe barrel and function as the interface between the syringe and its mating connection such as the needle. Terminations are offered in a number of different needle and connection

configurations to accommodate a broad range of applications. Below is a listing of the most popular syringe terminations. For a complete overview, please visit www.hamiltoncompany.com

N, Cemented Needle

For low volume syringes

The needles are cemented into the glass syringe barrel at a point corresponding to the zero graduation mark. With this termination, dead volume is limited to the internal volume of the needle. Not autoclavable. Needle gauge is determined by the syringe volume and are not user-selectable. For available needle gauges, see www.hamiltoncompany.com



SN, Special Cemented Needle

For low volume syringes

The special needle terminations are the same as the Cemented Needle terminations except they allow for a variety of user-defined gauges, lengths, and point styles to be attached.



LTN, Luer Tip Cemented Needle

For mid volume syringes

The needles are cemented into the glass syringe barrel at a point corresponding to the zero graduation mark. With this termination, dead volume is limited to the internal volume of the needle. Not autoclavable. Needle gauge is determined by the syringe volume and are not user-selectable. For available needle gauges, see www.hamiltoncompany.com



LTSN, Luer Tip Special Cemented Needle

For mid volume syringes

The special needle terminations are the same as the Luer Tip Cemented Needle terminations except they allow for a variety of user-defined gauges, lengths, and point styles to be attached.



LT, Luer Tip

The needles are removable and fit over a ground glass hub which is tapered in the shape of a male luer. The LT termination will accept most hypodermic needles but was designed specifically for use with Hamilton Kel-F needles. This termination increases the dead volume in the syringe, which may not be appropriate for some applications. Autoclavable when disassembled.

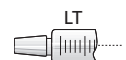

RN, Removable Needle

The needles are removable and are a Hamilton-specific design. The design allows the needles to seat precisely at the zero graduation mark of the syringe. Users can select the needle gauge, length, and point style to optimize the syringe for custom applications. Additionally, this termination allows for a removable needle without increasing the dead volume of the syringe and is ideal when there is a risk of the needle clogging. Autoclavable when disassembled. Repeated autoclaving will shorten syringe life. For more information, see our *Guide to Maintaining and Using Hamilton Syringes*.

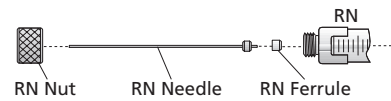

KH, Knurled Hub

The knurled hub is used exclusively on 7000 Series syringes. The hub handles up to 6000 psig maximum injection pressure. The needle is removable but with a limited number of gauges available because the plunger is fitted inside the needle. Autoclavable when disassembled. Repeated autoclaving will shorten syringe life. For more information, see our *Guide to Maintaining and Using Hamilton Syringes*.

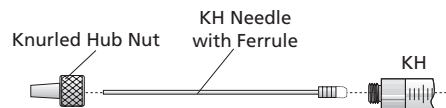

TLL, PTFE Luer Lock

This termination has a PTFE, male Luer taper with nickel-plated brass locking hub for use with Kel-F needles, metal hub needles, and universal connectors. Also, the TLL is used with Hamilton diluters/dispensers, OEM applications, and manual operations. Autoclavable when disassembled, except on 25 mL and greater syringes. Repeated autoclaving will shorten syringe life. For more information, see our *Guide to Maintaining and Using Hamilton Syringes*.

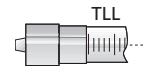

SL, SampleLock™

The sample lock incorporates an On/Off syringe valve with RN needle. This termination is used for headspace, environmental sample collection and storage, pre-pressurization of gaseous samples for GC analysis, and sample spiking. Not autoclavable.

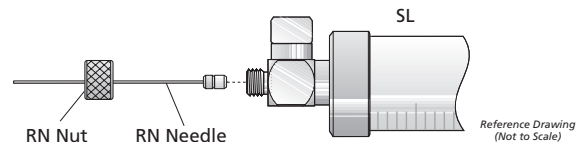

5. Needle Selection

Needle point styles range from blunt points for HPLC injections to conical points for penetrating vinyl and plastics. With most syringes, Hamilton provides a standard 2-inch needle of an appropriate gauge and point style. However, if your project requires a non-standard needle gauge or point style, Hamilton offers a wide variety of custom options.

Standard Needles

For most syringes, Hamilton has already selected the most common gauge (22 or 26), point style (2 or 3) and length (2 inches) for the average application. Throughout our web site and catalogs, the needles are designated by (Gauge/Length (inches)/Point Style), e.g., (22s/2/2). Review the Needle Point Style Chart to determine if a standard point style is suitable or if a custom needle is necessary for your application.

Custom Needles

For our custom needles, the user-definable parameters are indicated by asterisk like (22s/*/*). Review the following sections to fully define the custom needle that is required. There are limits to the gauge, length, and point style combinations that are available so contact Hamilton Customer Service at 1-888-525-2123 for assistance. Contact your local dealer for assistance outside the U.S.

Custom Needle Hubs

Choose a needle hub based on the syringe volume and the compatible termination for the specific syringe you have selected for your application.

SN, Special Cemented Needle: These are cemented needle syringes that allow for a user-defined needles to be attached from the factory.

LTSN, Luer Tip Special Needle: These are Luer Tip Cemented Needles that allow for user-defined needles to be attached from the factory.

N, Metal Hub Luer Lock Needle: These needles are designed for use with the TLL syringe termination and are available in a variety of gauges between 33 and 10.

KF, Kel-F Hub Luer Lock Needle: These needles are designed for use with the LT and TLL syringe terminations and are available in a variety of gauges between 31 and 10.

Small Hub Removable Needle: These needles are designed for use with the RN syringe termination on syringes with a nominal volume less than or equal to 100 μL . The needles are available in a variety of gauges between 33 and 22. Note: Remove the original needle and PTFE ferrule from the RN termination before inserting the replacement needle assembly.

Large Hub Removable Needle: These needles are designed for use with the RN syringe termination on syringes with a nominal volume greater than or equal to 250 μL . The needles are available in a variety of gauges between 26s and 22. Note: Remove the original needle and PTFE ferrule from the RN termination before inserting the replacement needle assembly.

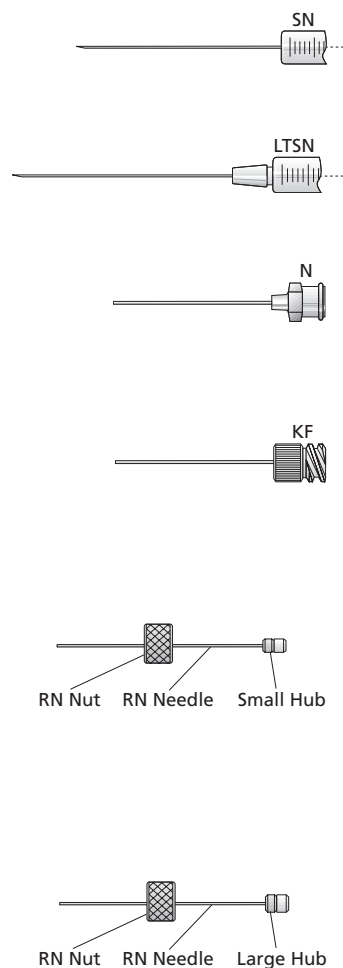

Point Styles and Applications

The correct point style varies depending on the intended application. Below are a few examples of common applications.







Animal Injections: Point Style 4 with a 45° angle allows for the most accurate targeting of a specific biological structure.

Manual HPLC Injections: Most manual injection valves are designed to be used with a 22 gauge Point Style 3 needle.

Manual GC Injections: Historically a Point Style 2 was required to achieve efficient septum penetration with minimized coring. With Hamilton's new line of GC septa there is evidence that indicates the Point Style AS will consistently extend septa life by as much as 10-fold.

Drawing Sample: Any point style will efficiently draw a sample, but when it is important to get the last drop out of a vial use Point Style 3 or AS to reach all the way to the bottom.

Needle Point Style Chart

Point Style 2		Sharp, beveled, curved, non-coring needle point recommended for septum penetration. Available gauges: 33-10.
Point Style 3		Blunt needle point for use with HPLC injection valves and for sample pipetting. Available gauges: 33-10.
Point Style 4	  30°  45°	Standard 12° beveled needle point is recommended for life science applications. Available gauges: 33-10. Special point styles such as 30°, 45°, or any other angle are available upon request.
Point Style 5		Conical needle with side port for penetration of septa, thin-gauged vinyls and plastics without coring. Available gauges: 26-10.
Point Style AS		Special conical style needle point used on autosampler syringes the non-coring needle point is recommended for septum penetration. Available gauges: 26-22.

Custom Needle Gauge and Length

When selecting a needle gauge it is important to keep in mind the volume of the syringe and the dead volume of the needle. For example, it will be very difficult to prime a 10 µL syringe if the dead volume in the needle is greater than 10 µL. Refer to the gauge index to choose a needle gauge with an appropriate µL/inch before selecting a needle. Select the minimum length that allows you to carry out your application comfortably.

Note: The 's' on a 22s needle represents a smaller I.D. (inner diameter) for the needle and a thicker needle wall for better durability. For example, a 26 gauge needle has an O.D. (outer diameter) of 0.46 mm and an I.D. of 0.26 mm while the 26s gauge needle has an O.D. of 0.47 mm and an I.D. of 0.13 mm. The 26s has half the I.D. of the 26 gauge needle. Also, the difference in the wall thickness nearly doubles with 26s gauge having a thickness of 0.18 mm while the 26 gauge is only 0.10 mm.

Gauge Index Table

Gauge	Nominal O.D.		Nominal I.D.		Wall Thickness		Volume µL/inch
	inch	mm*	inch	mm*	inch	mm*	
33	.0080-.0085	0.21	.0035-.0050	0.11	0.002	0.05	0.20
32	.0090-.0095	0.24	.0035-.0050	0.11	0.002	0.05	0.20
31	.0100-.0105	0.26	.0045-.0060	0.13	0.0025	0.06	0.34
30	.0120-.0125	0.31	.0055-.0070	0.16	0.003	0.08	0.45
28	.0140-.0145	0.36	.0065-.0080	0.18	0.0035	0.09	0.63
27	.0160-.0165	0.41	.0075-.0090	0.21	0.004	0.10	0.80
26s	.0184-.0189	0.47	.0045-.0055	0.13	0.007	0.18	0.26
26	.0180-.0185	0.46	.0095-.0110	0.26	0.004	0.10	1.25
25	.0200-.0205	0.51	.0095-.0110	0.26	0.005	0.13	1.25
24	.0220-.0225	0.57	.0115-.0130	0.31	0.005	0.13	1.80
23	.0250-.0225	0.64	.0125-.0140	0.34	0.006	0.15	2.17
22s	.0280-.0285	0.72	.0055-.0065	0.15	0.011	0.28	0.45
22	.0280-.0285	0.72	.0155-.0170	0.41	0.006	0.15	3.35
21	.0320-.0325	0.82	.0195-.0210	0.51	0.006	0.15	5.19
20	.0355-.0360	0.91	.0230-.0245	0.60	0.006	0.15	6.71
18	.0495-.0505	1.27	.0315-.0345	0.84	0.0085	0.22	14.08
17	.0575-.0580	1.47	.0405-.0435	1.07	0.008	0.20	22.84
16	.0645-.0655	1.65	.0455-.0485	1.19	0.009	0.23	28.25
14	.0820-.0840	2.11	.0610-.0600	1.60	0.010	0.25	51.07
13	.0940-.0960	2.41	.0690-.0730	1.80	0.012	0.31	64.63
12	.1080-.1100	2.77	.0830-.0870	2.16	0.012	0.31	93.07
11	.1190-.1210	3.05	.0920-.0960	2.39	0.013	0.33	113.00
10	.1330-.1350	3.40	.1040-.1080	2.69	0.014	0.36	143.28

*mm are nominal

Accessories, Replacement Parts, and Services

Hamilton offers a variety of accessories to improve durability and reproducibility, including the ones described below, as well as replacement parts for our syringes. Details can be found at www.hamiltoncompany.com

Cleaning Concentrate

The concentrate is a biodegradable cleaning agent for removal of stubborn residues. Hamilton Part No. 18311 (500 mL).

Needle Cleaning Kit

Contains a selection of various diameter tungsten wires as well as a biodegradable cleaning concentrate for cleaning plugged needles. Hamilton Part No. 76620. Additional cleaning wires and concentrate can be purchased separately.

Syringe Cleaner

The unit is designed to clean 7000 Series MICROLITER™ syringes with only heat (370 °C) or add a vacuum source (0.1 mm mercury) to remove suspected residuals. Hamilton Part No. 76610 (120VAC) and Part No. 76615 (220VAC).

Syringe Guide

The guide is easily installed on a syringe to prevent the plunger from bending or being pulled out. Two models are offered for different syringe volumes and series.

Reproducibility (Chaney) Adapter

The Chaney Adapter is easily installed on a syringe for consistent, reproducible injections. Also, the adapter prevents plunger bending while an adjustable stop provides increased precision and accuracy. Four models are available to accommodate a range of syringe volumes and series.

PB600 Repeating Dispenser

The PB600 (Hamilton Part No. 83700) can be used with liquids or gases to consistently dispense 1/50th of the syringe volume. The dispenser fits MICROLITER and GASTIGHT syringes with volumes up to 2.5 mL.

Digital Syringe™

The base unit can be used with Hamilton syringes in the 700, 1700, and 7000 series with nominal volumes between 0.5 µL and 500 µL. An easy-to-read LCD screen displays the volume contained in the syringe to within ±0.5% of the syringe's nominal volume. The Digital Syringe is ordered by adding 'DS' as a prefix to the required syringe part number.

Digital Syringes are automatically N.I.S.T. traceably calibrated to the base unit prior to shipment. Recalibration service is available for the Digital Syringe. Contact Hamilton Customer Service Department to obtain an RGA Number (Returned Goods Authorization Number). Include the syringe part number used with the base unit on the RGA and return the digital unit without the syringe. The customer will be charged the calibration fee plus the cost of a new syringe.

N.I.S.T. Traceable Certification

This calibration service is available for most of our precision syringes. A Certificate of Calibration is shipped with the product and the procedure is performed with an unbroken chain of calibrations with N.I.S.T. traceable weights. Calibrated syringes must be specified at the time of ordering by adding the prefix 'CAL' to the beginning of the syringe's part number. For example, to order a 701N, 10 µL syringe (Hamilton Part No. 80300) as a calibrated syringe, request Part No. CAL80300.

Additional Technical Information at www.hamiltoncompany.com

The following information is available on our web site and as pdfs.

Hamilton Precision Syringes Care and Use

With proper care and handling, Hamilton syringes will provide unsurpassed performance year after year. See our complete *Guide to Maintaining and Using Hamilton GASTIGHT[®], MICROLITER[™], and Specialty Syringes*.

Determining the Performance of Hamilton Syringes

Follow the protocol on this document to confirm the accuracy of a syringe. The Hamilton Company Quality System is ISO 9001-2000 certified.

Inner and Outer Dimensions

For applications and projects where the physical dimensions of a syringe are important, specifications are provided for the most popular syringes in our product line.

Product Instruction Sheets

Electronic versions of the documentation shipped with new products containing information on assembly, use, replacement parts, etc. Refer to these sheets, if you have misplaced an original instruction sheet or would like to see more information on a specific product prior to purchase.

Syringe Graduations

Occasionally, users have asked for information relating to the scale divisions on a syringe to the delivery volume. A series of tables detail this information for all of our syringes.

Technical Support

Frequently Asked Questions

Many of your questions can be answered by visiting the FAQ page of our web site at www.hamiltoncompany.com

Online

Our technical staff will promptly answer questions sent by email to sales@hamiltoncompany.com

Telephone

For all other technical issues, call 1-888-525-2123 for Hamilton Technical Service assistance. For assistance outside the U.S., contact your local dealer.



HAMILTON
THE MEASURE OF EXCELLENCE™

Hamilton Company

4970 Energy Way
Reno, Nevada 89502
Toll-Free: 800-648-5950
Telephone: 775-858-3000
Fax: 775-856-7259
Email: sales@hamiltoncompany.com

Hamilton Bonaduz AG

Via Crusch 8
CH-7402
Bonaduz/Switzerland
Telephone: 00800-660-660-60
Fax: +41-(0)81-660-60-70
Email: marketing@hamilton.ch

Quality Hamilton Products—

MICROLITER™ Syringes
GASTIGHT® Syringes
Chromatography Syringes
Syringes for Life Science
Instrument Syringes
SoftGrip™ Pipettes
Miniature Valves
Modular Valve Positioner
Laboratory Fittings, Adapters, and Tubing
Precision Syringe Pumps
MICROLAB® Diluters and Dispensers
Electrochemical Sensors
DURACAL™ Buffer Solutions
HPLC Columns and Resins

Laboratory Automation for—

Drug Discovery
Genomics
Proteomics
Forensics
In Vitro Diagnostics

<http://www.hamiltoncompany.com>
Sales and Support USA 1-888-525-2123

The following are trademarks of Hamilton Company

AdvanTip™
Pipette Safe™
SoftGrip™
SoftTouch™
SoftTop™
SoftAide™

The following company trademarks have been used in this catalog

PCR protected by patents issued to F. Hoffman-La Roche Ltd.